

# INSTRUCTIONS

For the Operation  
and Care of

# GOULD BATTERIES

In Starting and  
Lighting Systems



WITH THE  
*Dreadnaught*  
PLATES







**T**HIS BOOK contains instructions necessary for the proper care of storage batteries for automobile starting and lighting. The instructions are in condensed and simple form and can readily be followed by the owner of an automobile.

A storage battery is subject to wear—in normal use it will one day wear out, as will tires. It is also subject to neglect—but remember the importance of the battery—it is the heart of the starting, lighting and frequently of the ignition systems—give it a fraction of the care its importance seems to indicate and it will repay your care with absolutely dependable service and greatly increased life.

Gould batteries are made by a pioneer in storage-battery building. For twenty years the Gould Storage Battery Co. has been designing and building storage batteries for every service, including train lighting, vehicle, railway and fire alarm signal, stand-by service for great central station and street railway companies, and submarines for five of the world's great navies. The Gould automobile battery is made in the same great plant and under the same experienced and expert supervision as other Gould Batteries, and may be relied on for the kind of performance that has made them famous.

The Gould organization includes district offices in six cities, thirty special distributors and about twenty-five hundred dealers, who are ready at any time to test your battery and advise you regarding it.



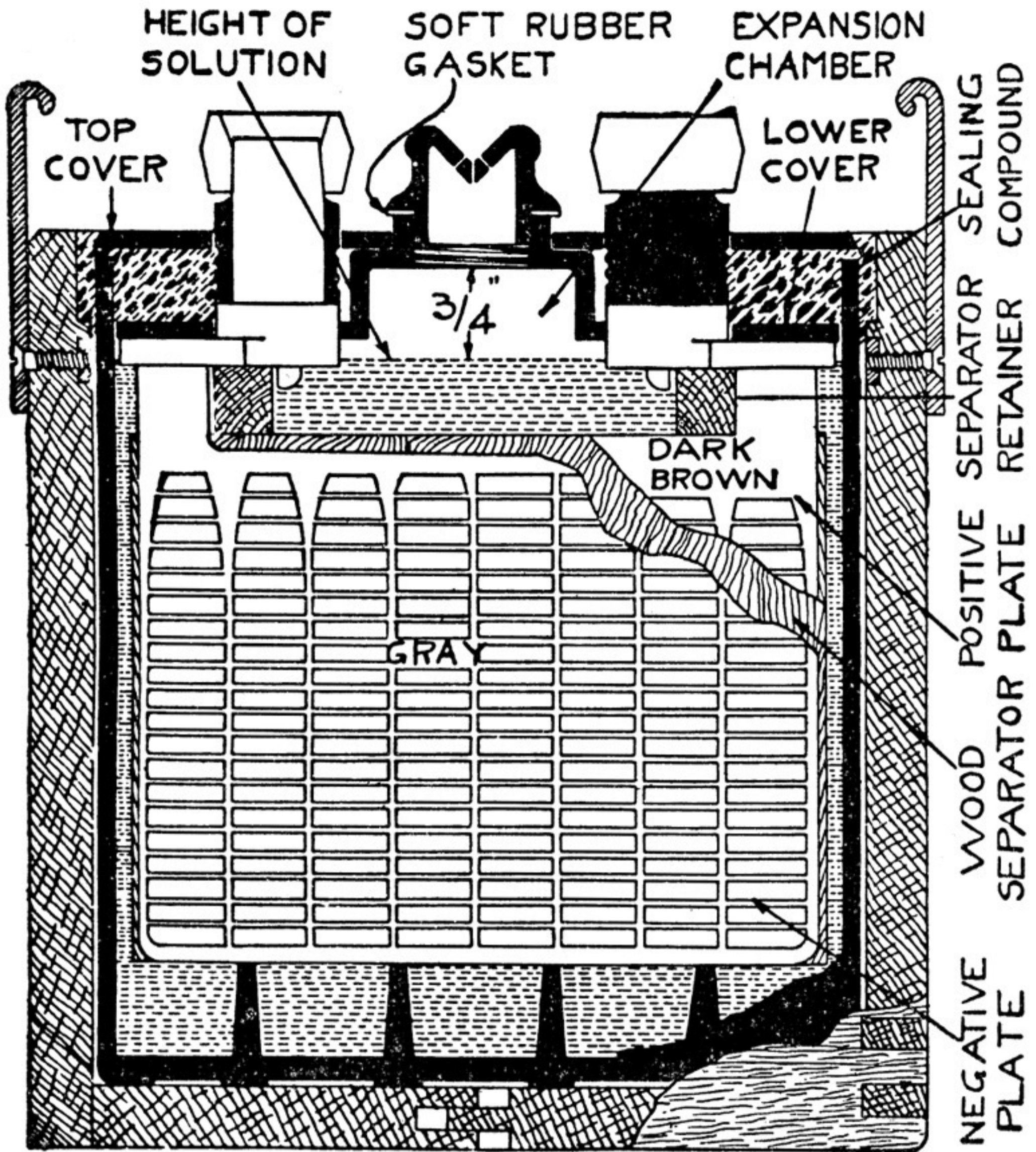
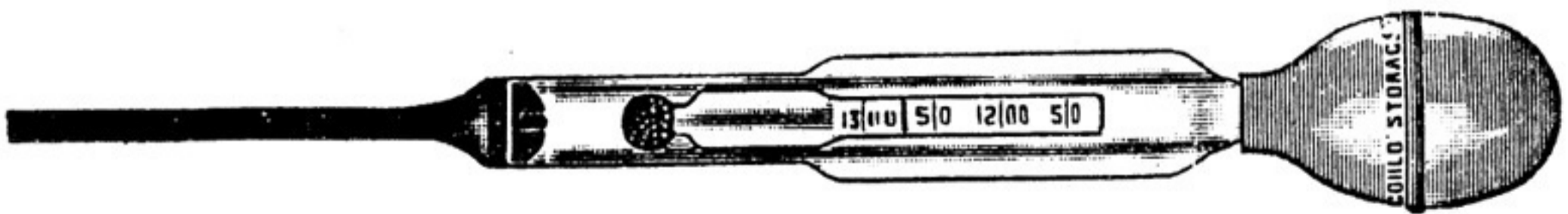

Fig. 1

CELL CUT AWAY TO SHOW CONSTRUCTION AND PROPER LEVEL OF SOLUTION



HYDROMETER TESTING SET  
AN ESSENTIAL TO BATTERY INSPECTION

May be had from Gould dealers, or sent postpaid anywhere in the United States on receipt of \$1.20.



## ***IMPORTANT THINGS TO KEEP IN MIND***

---

1. Keep the liquid above the tops of the plates at all times by adding pure water only to each cell.

2. Keep the battery fully charged. The state of charge can be definitely determined by taking hydrometer readings, and if these show a discharged or partially discharged condition, have the battery charged from an outside source.

Inspect your battery regularly, always taking hydrometer readings before adding water. As a general rule it is well to inspect once each week.

Remember that a new battery should be given the most careful attention—a battery is more easily ruined by neglect during the first month than later.



## Care of a New Battery

When a battery is delivered or a new car with battery installed, the battery should be carefully inspected, **at the start.**

Remove the vent plugs in all cells and read the specific gravity with the hydrometer. If the reading is below 1250 the battery is discharged and should be removed from the car and charged from an outside source.

If the hydrometer reading is 1250 or above add pure water where it is needed to bring the level  $\frac{3}{4}$  in. above the tops of the plates. See Fig. 1.

Replace vent caps and screw them down firmly. Wipe the battery clean with cotton waste.

Be sure that the battery is securely held down in its box and that battery connections are clean and tight.

In working around the battery look out for acid getting on hands or clothes. If acid is spilled on the battery, wipe off with cotton waste moistened with a weak solution of ammonia.



## Testing with the Hydrometer

The storage battery is made up of a number of cells, connected in series by the connectors at the top of the battery. Each cell is provided with a vent cap and must be tested as follows:

- Remove vent caps*      Remove the vent caps from the cells.
- How to test with hydrometer*      Test the solution in each cell with an hydrometer testing set. To use the hydrometer squeeze the rubber bulb, then insert the end of the rubber tube in the cell and well below the surface of the liquid. Then slowly release the rubber bulb drawing the solution into the glass chamber until the hydrometer floats freely. Note the point at which the hydrometer stem emerges from the solution. Then slowly withdraw the tube from the solution and squeeze the bulb to return the solution in the hydrometer set to the cell.
- Density of solution*      The point at which the hydrometer stem emerges from the solution denotes the density thereof and the density indicates the state of charge of the cell.
- Cell fully charged*      For the convenience of the user the Gould hydrometer has a red band around the stem. When the cell is fully charged the red band is at the level of the solution. (See Fig. 2, page 6.)
- Cell half charged*      If the cell is not fully charged the red band sinks below the surface of the solution. When the hydrometer reads 1225 the cell is about half charged and the lamps and starter should be used sparingly. (See Fig. 3, page 6.)
- Cell discharged*      When the hydrometer reads 1180 the cell is completely discharged. (See Charging, page 10.)



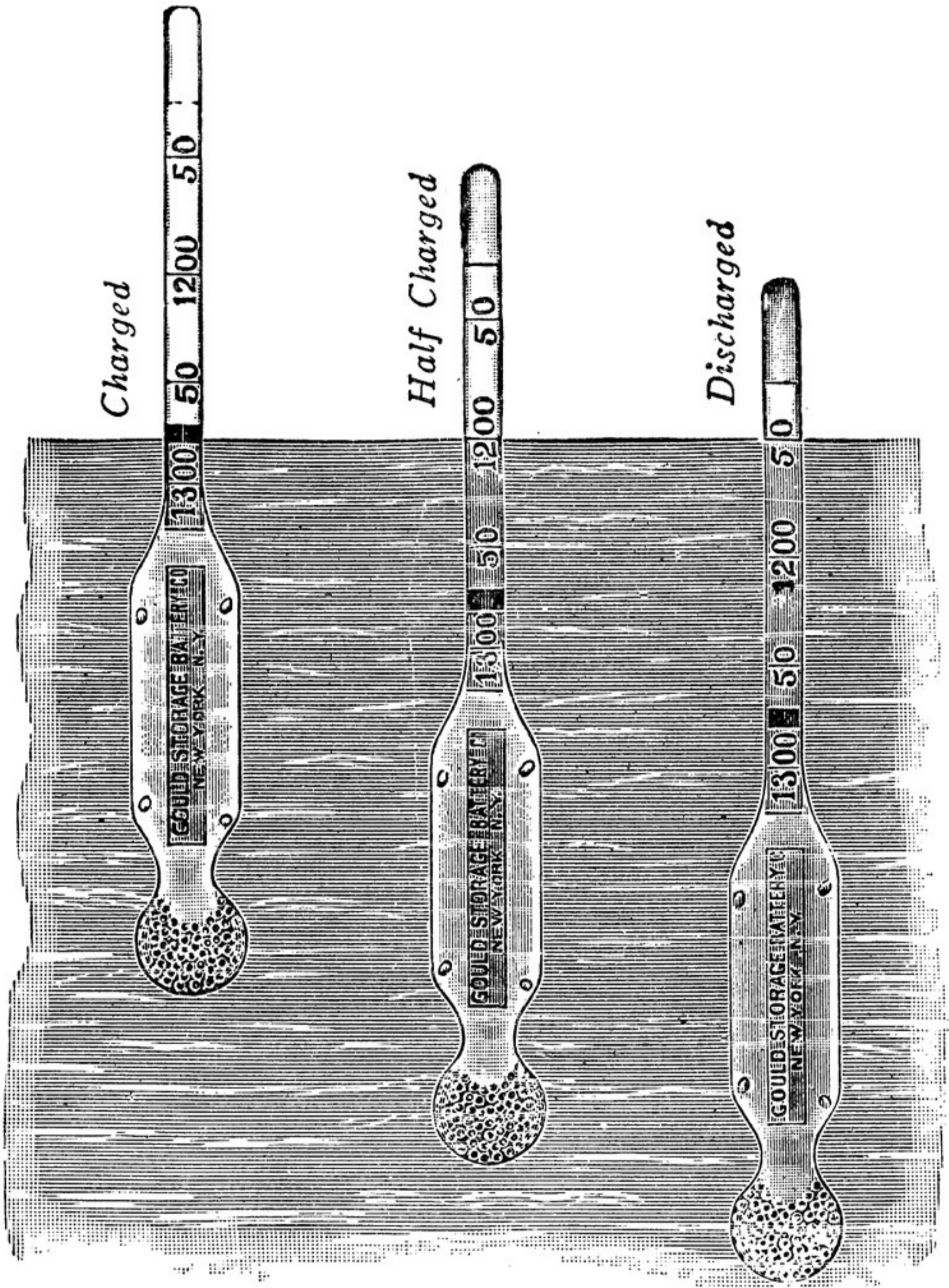

Fig. 2

Fig. 3

Fig. 4

CUT SHOWING STATE OF CHARGE OF CELL  
AS INDICATED BY THE DENSITY OF THE  
SOLUTION



*Reasons  
for dis-  
charged  
cell*

The electrical system is designed so that in normal operation the electrical generator on the car keeps the battery fully charged. However, it sometimes happens that abnormal conditions will cause the battery to become discharged, such as—

Excessive use of lamps.

Frequent stops and consequent excessive use of starter

Slow running or short runs between stops.

Partial short circuit in wiring.

**A discharged battery should be given a full charge at once, either from the generator on the car or from an outside source.**

*Indication  
of trouble*

If one cell shows a marked difference from the others in the same battery, and this difference should continue from week to week, it is an indication that that particular cell is in trouble, and the battery should be examined at a service station

*Example*

For instance, if two cells read around the 1250 mark and one cell reads around the 1200 mark there may be trouble of three kinds

1st Leaky jar This will be indicated if more water has to be added each week to this cell than to the others, the loss of electrolyte causing reduction in gravity

2d. Short circuit, causing the cell to discharge itself

3d. An uneven hydrometer reading may be caused by loss of electrolyte—slopping around a loose vent, thus requiring the addition of an abnormal amount of water

In any of the above cases the battery should be taken to a service station—in the first two for repair, in the last case to have the electrolyte equalized.



## Adding Water

*When to  
add  
water*

After testing with the hydrometer—*not before*, pure water should be added to each cell to replace that lost by evaporation.

*A reliable hydrometer test cannot be made after adding water until it has been mixed with the solution by charging or running the car, so if there is insufficient water above the plates for the hydrometer test, add water and then run the car a few hours, after which you may make the test.*

Evaporation is more rapid in hot weather than in cold, but it is a good rule to inspect once a week. **Failure to keep the solution above the tops of the plates will result in damage both to plates and insulation.**

*Care in  
cold  
weather*

In winter add water just before running the car. This, because if the water is allowed to rest on top of the solution it may freeze, whereas the electrolyte of a normal fully charged battery will not freeze at 60 deg below zero.

*Height  
of  
solution*

The proper height to which to fill the cell is about  $\frac{3}{4}$ " above the tops of plates, as shown in Fig. 1.

*Kind of  
water to  
use*

Use distilled water, melted artificial ice, or clear rain water that has not come in contact with metal roof or container

*How to  
keep  
water*

Water should be kept in a clean glass or china vessel. It should not come in contact with any metal.

**Nothing but water must be put into the cells.** The electrolyte consists of a mixture of sulphuric acid and water. Water evaporates and has to be replaced, but the acid does not evaporate. Therefore, if acid is added the solution becomes of more than normal density, resulting in serious damage to the cell. Acid should only be put into a cell to replace spillage or leakage, and then preferably by a competent battery man.



<i>Solution low in one cell; take to service station</i>	If the solution is found to be markedly lower in one cell than that in the other cells it indicates, first, that the solution has spilled due to failure to tightly replace the vent plug after filling; or, second, that the jar has developed a leak; and the battery should be taken to a service station and have solution of the proper proportions added to the cell and the jar replaced if necessary.
<i>Replace vent caps</i>	After filling the cells with water, replace the vent caps and see that they are screwed down firmly.

## Cleaning Battery and Terminals

After inspection of the condition of the cells, examine the terminals and leading-in wires to be certain they are both clean and tight. Loose and corroded terminals cause trouble that is easily avoided, because the battery cannot give out sufficient current for starting if contact surfaces between the cables and battery terminals are imperfect.

<i>Cleaning terminals</i>	If there is apparent corrosion at the terminals, they should be removed, contact surfaces scraped clean and then replaced, being sure that they are screwed up tightly. A coating of vaseline over the terminals will minimize future difficulty.
---------------------------	---

<i>Keep the battery clean</i>	Do not allow dirt or electrolyte to accumulate either on top of the battery or on the wood case
-------------------------------	---

When making your regular inspection wipe the top and box clean with cotton waste—if electrolyte has been spilled moisten the waste with a solution of one part ammonia to ten parts water. Take care that the ammonia solution does not get into the cells.

<i>Keep battery firmly in place</i>	Lastly, make sure that the battery hold-downs are firmly in place. If allowed to remain loose the jarring may cause broken jars and connectors.
-------------------------------------	---



## Charging

The following conditions indicate that the battery should be given a special recharge.

- Indications of need for charging*
1. If hydrometer reading indicates a discharged condition.
  2. When lamps burn dimly when running on the battery. This will not be noticed when running fast, as in this case current comes from the generator.
  3. When battery is out of service it should be given a charge every month to keep it in condition.

*Charging on the car*

If long runs are in prospect in which lights and starter will be little used, it may be possible to recharge the battery on the car

**In charging from an outside source, proceed as follows:**

*How to charge the battery*

Disconnect cable leads and hold downs and remove battery to the charging circuit (Some owners have recharging outfits in their garages, in which case battery may be charged in the car.)

Remove vent plugs and fill with pure water to the proper level (See page 2.)

**Connect the positive wire of the charging circuit to the positive terminal of the battery and the negative wire of the circuit to the negative terminal of the battery.**

If the polarity of the charging is not marked or known, it can be determined in the following manner:



*To  
determine  
polarity*

Put a weak solution of electrolyte, or water with a pinch of salt in a glass, insert the ends of the wires in the solution with the current turned on. Bubbles will rise from the negative wire.

**Making connections with wrong polarity will result in reversal and serious damage to the battery.**

After making connections start the charge at the ampere rate shown on the name plate or in the table on page 12

The charge must be continued until the gravity as shown by hydrometer test has reached a maximum. Charge should not be stopped till the gravity ceases to rise through a period of five hours. Voltage of each cell should be approximately 2.7 volts at the end of the charge, while the charging current is on, this voltage will drop to nearly 2 volts per cell when the charging current is off. Gassing or bubbling of the cells is an indication of full charge

**If the gravity of the solution should at any time read over 1300 some of it should be drawn off and replaced with water—full charge reading should be between 1275 and 1300.**

If the battery heats up during charge, turn off the current until it cools and then start at a lower rate.

*Time  
required  
to charge*

To charge a battery at normal rate requires about twenty-four hours. If it is desired to complete the charge in a less time the charge may be started at double the normal rate, but must be reduced as soon as the cells start gassing. Temperature must also be closely watched.



## Table of Charging Rates

Types	6 Volts	12 Volts	16 Volts	18 Volts	24 Volts	<i>Amperes</i>
ASL	625	1225	...	1825	2425	5
AEL	645	1245	....	1845	2445	7
ACH	663	1263	...	1863	2463	10
ALG	681	1281	...	..	....	13
	699	....	....	..	....	16
	615	....	...	..	....	18
	632	....	.	....	..	21
BSL, BEL	620	1220	1620	1820	2420	4
BSH, BEH	635	1235	1635	1835	2435	6
BML, BHG	650	1250	1650	1850	2450	9
BSPH, BSLP	670	1270	1670	1870	....	11
	695	..	....	....	....	13
	610	.	....	....	..	16
	655	...	....	....	....	21
BSHH, BEHH	610	..	..	...	....	16
	630	..	....	..	....	21
	675	..	..	..	....	23
	1280	...	..	..	....	13
ES, EE	678	.	...	..	....	13
ESJ, EEJ,	692	....	...	...	....	15
EJG, ESK,	635	..	.	..	....	21
EEK	....	...	...	..	....	..
F	614	..	..	...	..	18
G, GMV	616	...	...	....	..	18
I	..	...	,	....	2413	2



## The Charging Circuit

A storage battery must be charged from a direct current source. If only alternating current is available a motor generator set must be used to convert the alternating to direct current. These sets are obtainable in small sizes suitable for charging from one to four 6-volt batteries and are much more economical in operation than charging from high voltage direct current sources.

When you desire to charge from 110-volt or 220-volt direct current, a bank of lamps must be set up as per the diagrams shown in Figs. 5 and 6.

With 110-volt current one thirty-two candle power carbon lamp must be inserted in multiple, or two sixteen candle power lamps for each ampere of charging current desired. See Fig. 5.

In charging with 220-volt current, two 110-volt lamps in series should be used in place of each lamp needed with 110-volt current. See Fig. 6.

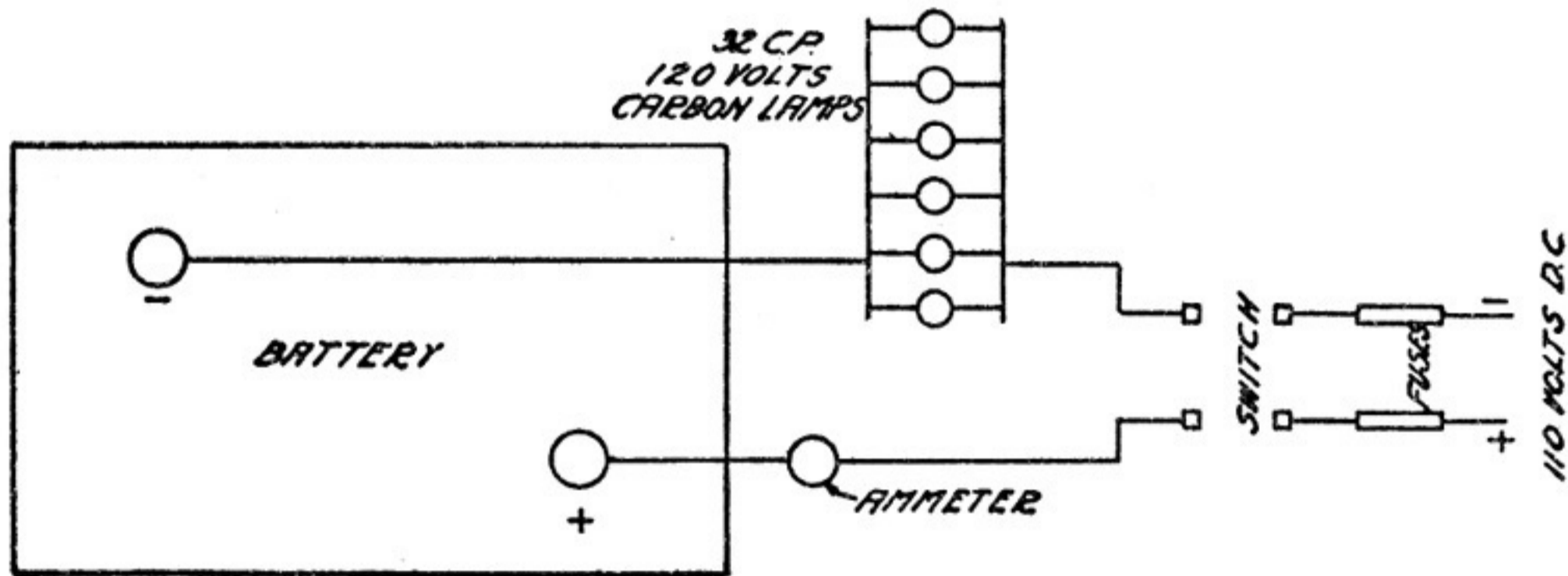

Fig. 5—Charging through bank of lamps on 110-volt circuit

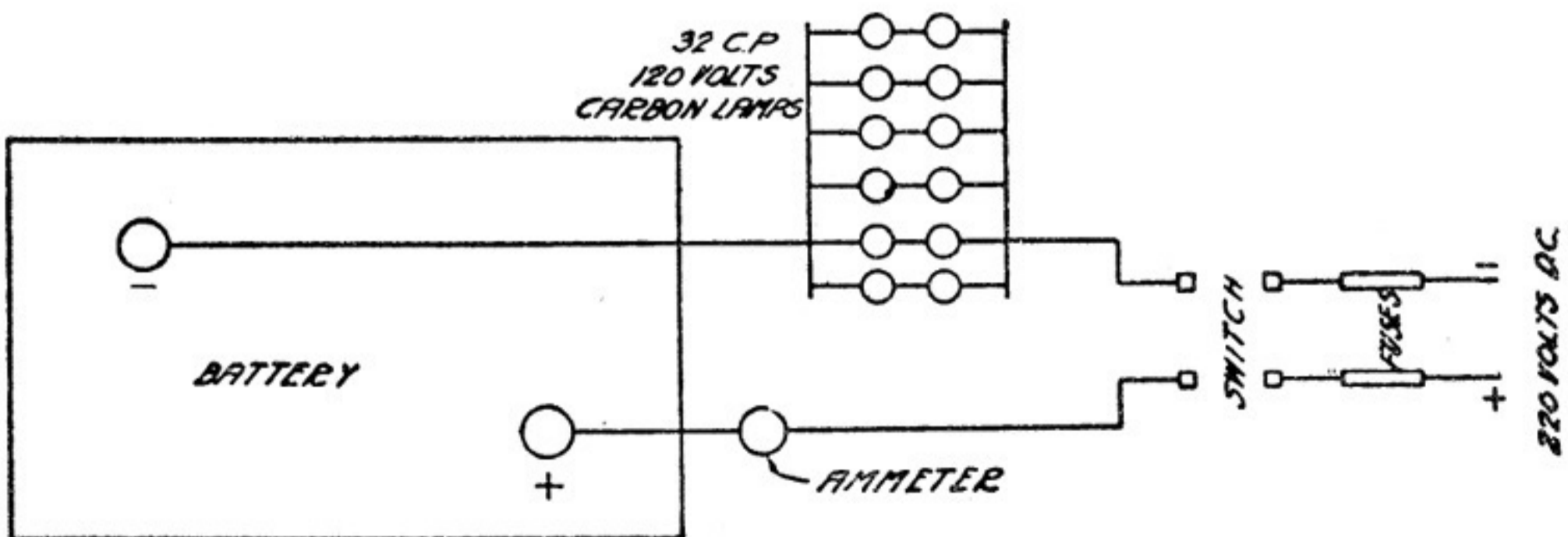

Fig. 6—Charging through bank of lamps on 220-volt circuit



## Looking for Trouble

When the battery becomes discharged, have it recharged at once, but unless you are sure that abnormal use of starter or lights are responsible, check up the system as follows:

*Generator  
not  
charging*

With battery connected run the engine at rate of about fifteen miles per hour and check the charging rate by the ammeter. Generator should develop normal rate at fifteen to twenty miles.

*Grounded  
wiring*

With all lamp switches on but lamps removed from sockets connect a voltmeter from one terminal of the battery to frame of car. If the system is a single wire system, first remove the ground wire from the battery and test from this terminal—otherwise test from both terminals. If the voltmeter shows any reading have the wiring gone over by an expert.

If no voltmeter is at hand an indication may be obtained by disconnecting one battery cable and striking it against its battery terminal. Sparks indicate a short circuit in the wiring.

*If  
starter  
fails*

If the starter fails to crank the car, first examine the battery connections and make sure they are clean and tight.

If the lamps stay bright when starter pedal is depressed trouble is in wiring.

## Shipping Storage Batteries

To insure safe transit of storage batteries, these diagrams and instructions *must be* followed.

1st. The case should be built of strong lumber (1½" preferably), and of ample size to allow packing with excelsior top, bottom, sides and ends to a thickness of two to three inches. Nail strongly.

2d. When the case is complete (except cover), place a thick, even layer of excelsior (or packing straw) in the



bottom and set in the battery *right side up*. Lay paper (preferably paraffined) over top of battery to keep it clean then pack tightly with excelsior sides and ends.

3d. Now lay sufficient packing material on top of the battery so that cover will compress it tightly, stuffing it under cover boards as they are put on.

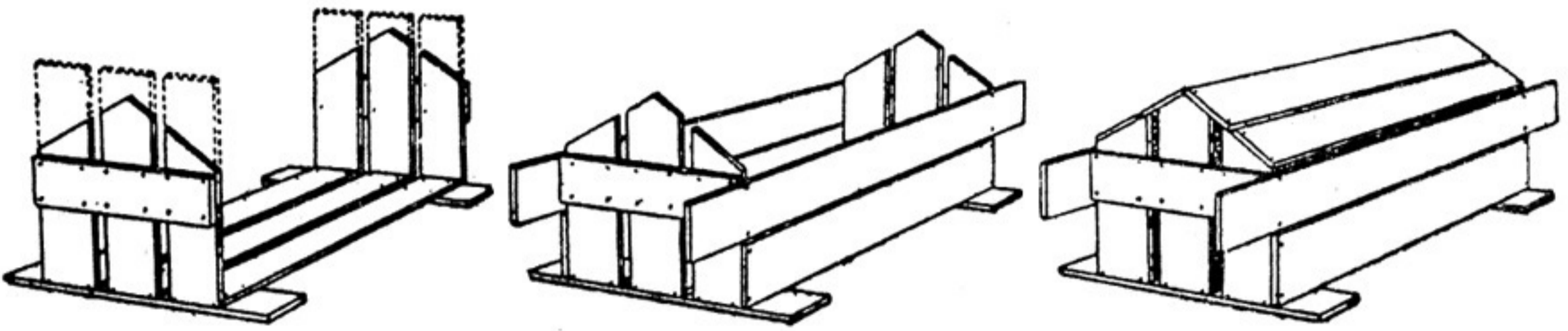

*The extended boards at bottom, and the gable roof are provided to prevent the battery from being tipped over; extensions of sides for carrying.*

BOX SHOULD BE PLAINLY LABELED :  
"HANDLE WITH CARE"

## Car Out of Service

**When the car or battery is to be out of service for any considerable period special precautions should be taken with the battery.**

If the period of idleness is not to exceed one month it will be enough to be sure that the battery is fully charged and the level of the solution well over the plates when the car is laid up. It is also advisable to disconnect the wires leading from the battery.

If the battery is to be out of service for six weeks or over the engine should be run every two or three weeks sufficiently to keep the battery fully charged or it should be turned over to a reliable service station for storage.

Charging is necessary to prevent sulphation of the plates and in winter to avoid freezing.



# Gould Storage Battery Co.

30 East 42nd Street, New York City

Works: Depew, N. Y.

---

## DISTRICT OFFICES

CHICAGO.....225 East 22d Street  
DETROIT.....Cor. Cass & Sibley Aves.  
SAN FRANCISCO.....1660 Pine Street

---

## GOULD DISTRIBUTORS

Carrying complete wholesale stocks of batteries and parts

Amplex Storage Battery Company.....Cleveland, O.  
Julius Andrae & Sons Co.....Milwaukee, Wis.  
Auto Sales Company.....Memphis, Tenn.  
B-R Electric Co.....Kansas City, Mo.  
Capital Electric Co.....Salt Lake City, Utah  
Central Texas Battery Co.....Waco, Texas  
Doubleday-Hill Electric Co.....Washington, D. C.  
Doubleday-Hill Electric Co.....Pittsburg, Pa.  
Fobes Supply Co.....Portland, Ore.  
Fobes Supply Co.....Seattle, Wash.  
Gray Electric Co.....Springfield, Ohio  
Louisiana Battery & Electric Works.....New Orleans, La.  
McGraw Co.....Sioux City, Iowa  
McGraw Co.....Omaha, Nebr.  
Michigan Tire & Accessories Co.....Grand Rapids, Mich.  
Montana Electrical Co.....Butte, Montana  
Northwestern Electrical Equipment Co.....St. Paul, Minn.  
Queen City Motor Delivery Co.....Cincinnati, Ohio  
Robertson-Cataract Electric Co.....Buffalo, N. Y.  
Southwest General Electric Co.....Houston, Texas  
Southwest General Electric Co.....Dallas, Texas  
Varney Electrical Supply Co.....Evansville, Ind.  
Varney Electrical Supply Co.....Indianapolis, Ind.  
Wesco Supply Co.....St. Louis, Mo.  
Wetmore-Savage Co.....Boston, Mass.  
Weinstock-Nichols Co.....Los Angeles, Cal.  
Weinstock-Nichols Co.....Oakland, Cal.  
Weinstock-Nichols Co.....San Francisco, Cal.

## CANADIAN REPRESENTATIVE

J V. Elliot.....Hamilton, Ont.

## CANADIAN DISTRIBUTORS

Atlantic Auto Company, Ltd.....Amherst, Nova Scotia  
Battery Service & Sales Co.....Hamilton, Ont.  
Electric Service Co.....Calgary, Alberta  
Electrical Repairing & Engineering Co.....Vancouver, B. C.  
William Edward Garnett.....Winnipeg, Manitoba  
International Electric Co., Ltd.....Montreal, Quebec  
Magneto Service Station, Ltd.....Regina, Saskatchewan  
Burt. L. Perry, Ltd.....Edmonton, Alberta

In addition to the above there are about 1000 Gould Service Stations and 1500 Dealers in the United States and Canada. Write our nearest office or distributor for the address of the station nearest you.







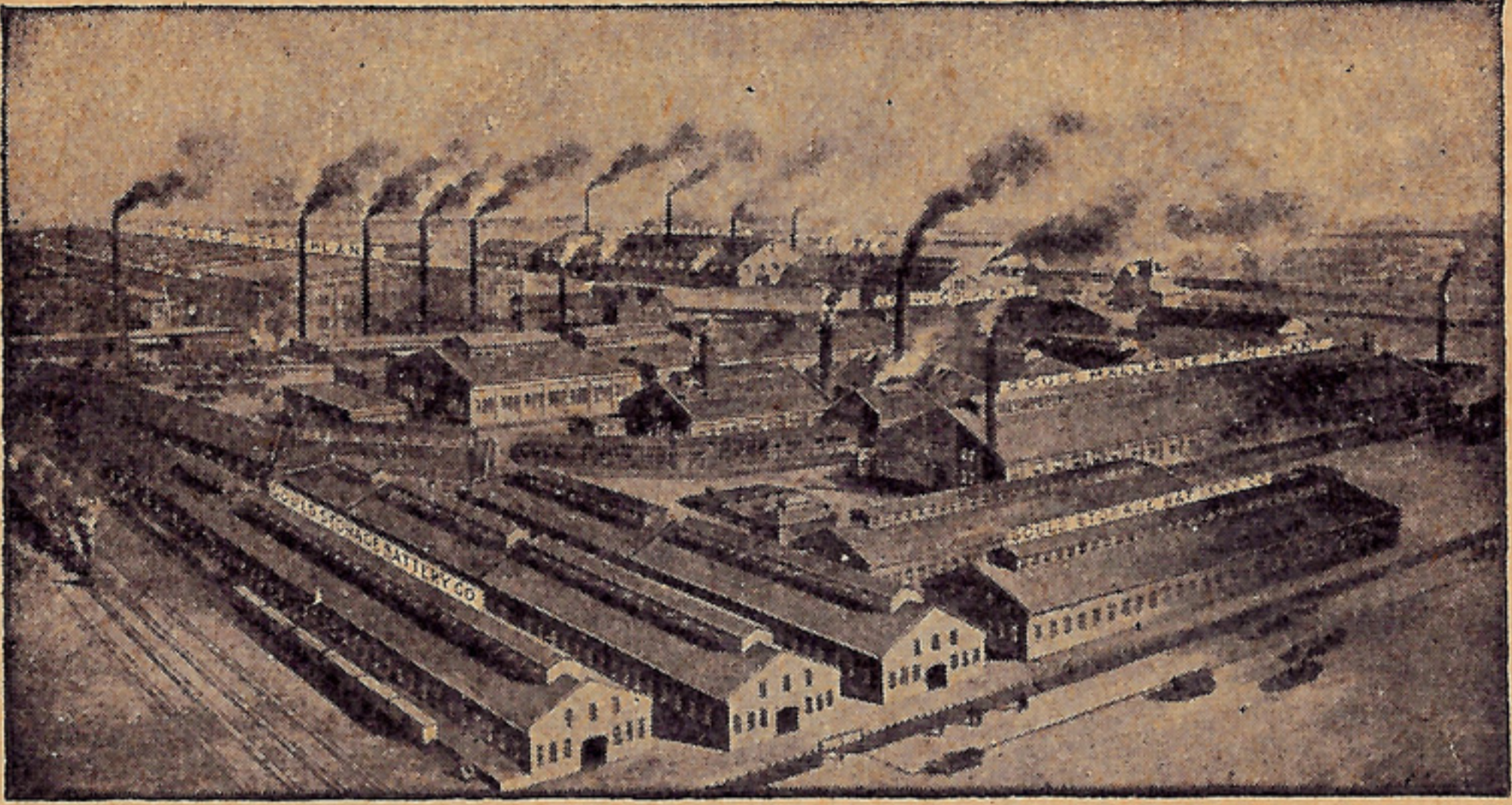

## The Gould Plants

Depew, N. Y.

**T**HIRTY-FOUR buildings, fifty-three acres, more than four thousand employees, over five miles of railroad track inside the fences. A little world of its own, with Police Department, Fire Department and Post Office Department. The Depew Plant is twenty-five years old **AND IS GROWING LARGER EVERY YEAR.**

Posted on November 6, 2020  
By Brian D. Szafranski, Elma NY USA  
Please do not reprint or reproduce  
this document for commercial gain.